

Model 213/213-F











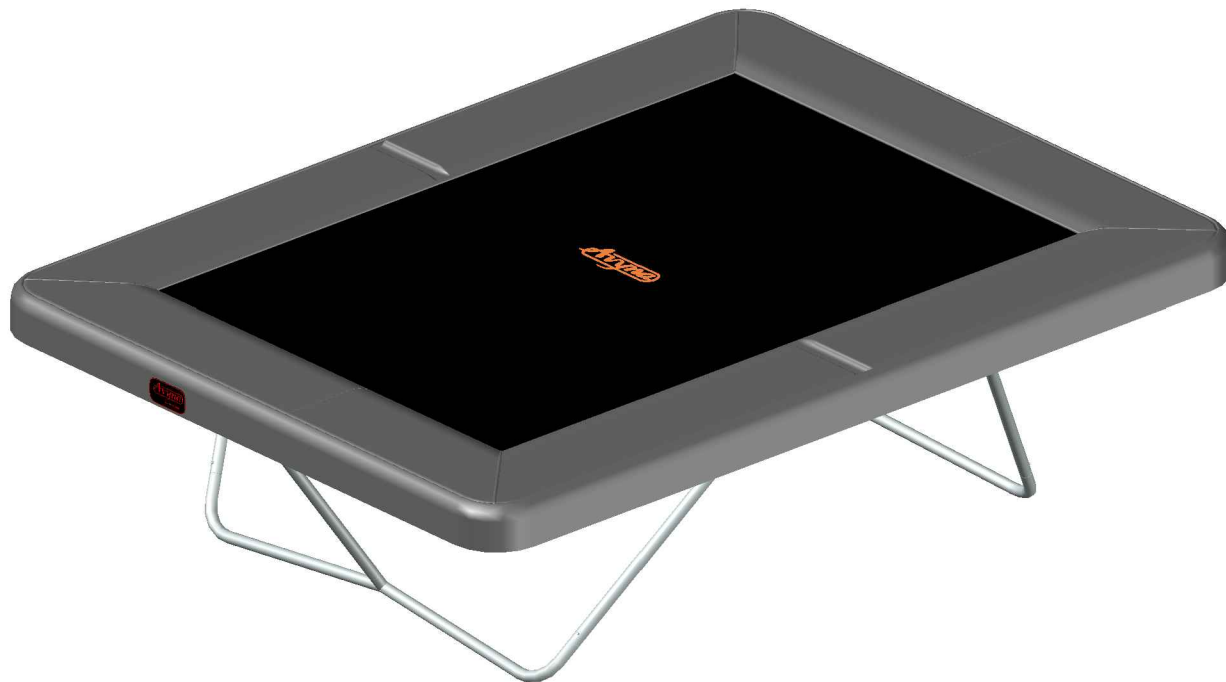



Avyna

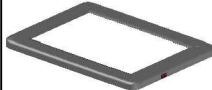

Rectangular trampolines

Assembly manual

Model 213



Model 213 275x190 cm			
	Quantity	Part number	
Jumping mat	1	TEPL-213-222	
Galvanized spring L=175mm ø3.2mm	46	TEPL-200-211/C (red cap)	
Galvanized spring L=175mm ø3.8mm	10	TEPL-200-211/C (green cap)	
Safety pad	1	TEPL-213-333-green or AVGR-213-333-grey or CAM-213-333-camouflage	
Fastener for Safety pad	8	TEPL-ELAS-A	
W-tube	2	TEPL-213-111	
I-tube, L=520mm	4	TEPL-213-1121	
I-tube, L=650mm	2	TEPL-213-1122	
C-tube	2	TEPL-213-1142	
K-tube	2	TEPL-213-1141	
Screw M6	4	M6x45	

Model 213 275x190 cm			
	Quantity	Part number	
Tool for spring	1	TOOL-SPRING	
Fastener for Safety pad	20	TEPL-ELAS-B	
Allen key	2	ALLEN-KEY	
Users Manual	1	208010101	
Warning Card	1	208040101	
Tie rip for warning card	1	209010102	
Safety manual	1	208010301	

1.

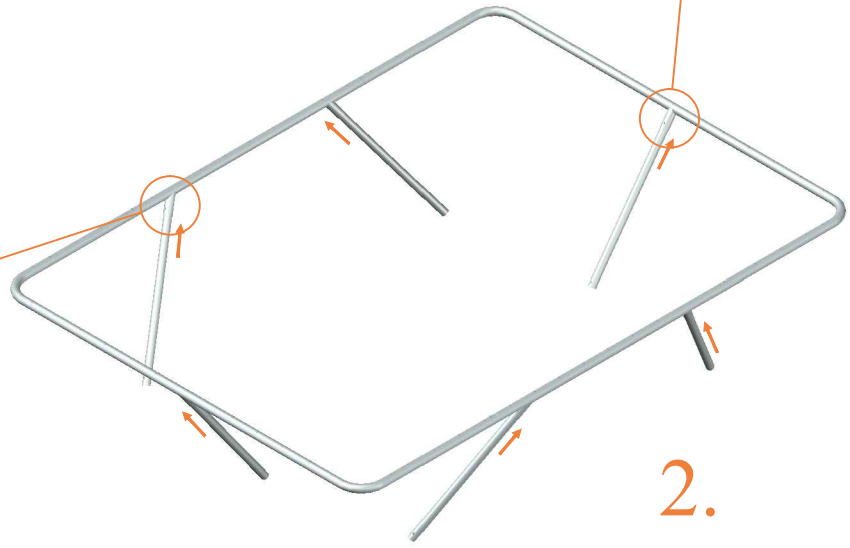
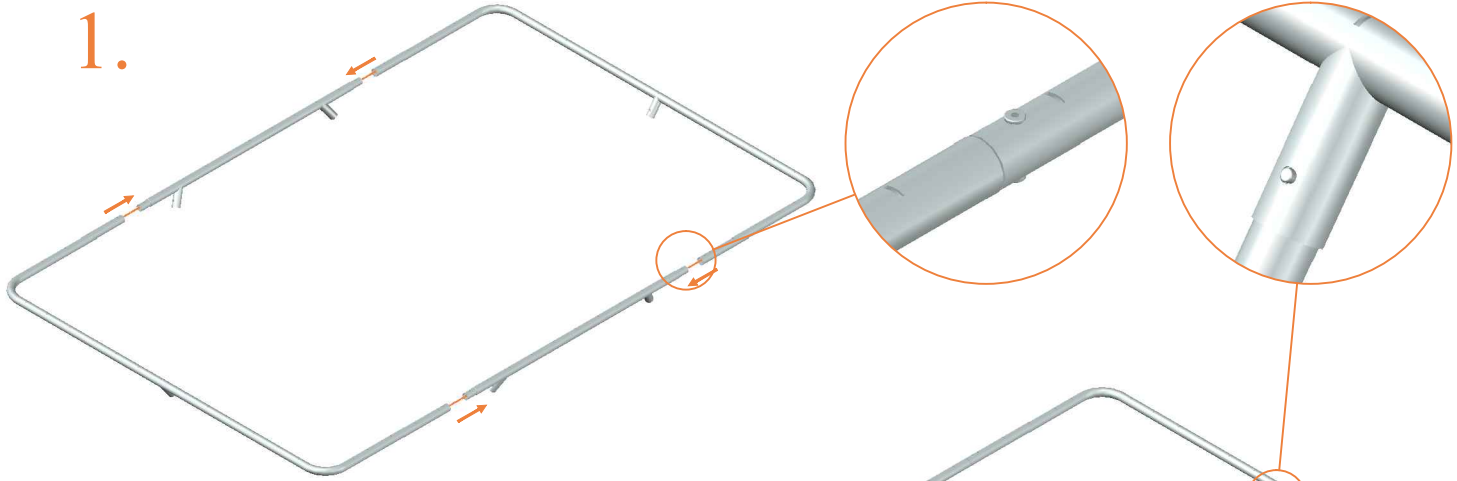

2.

3.

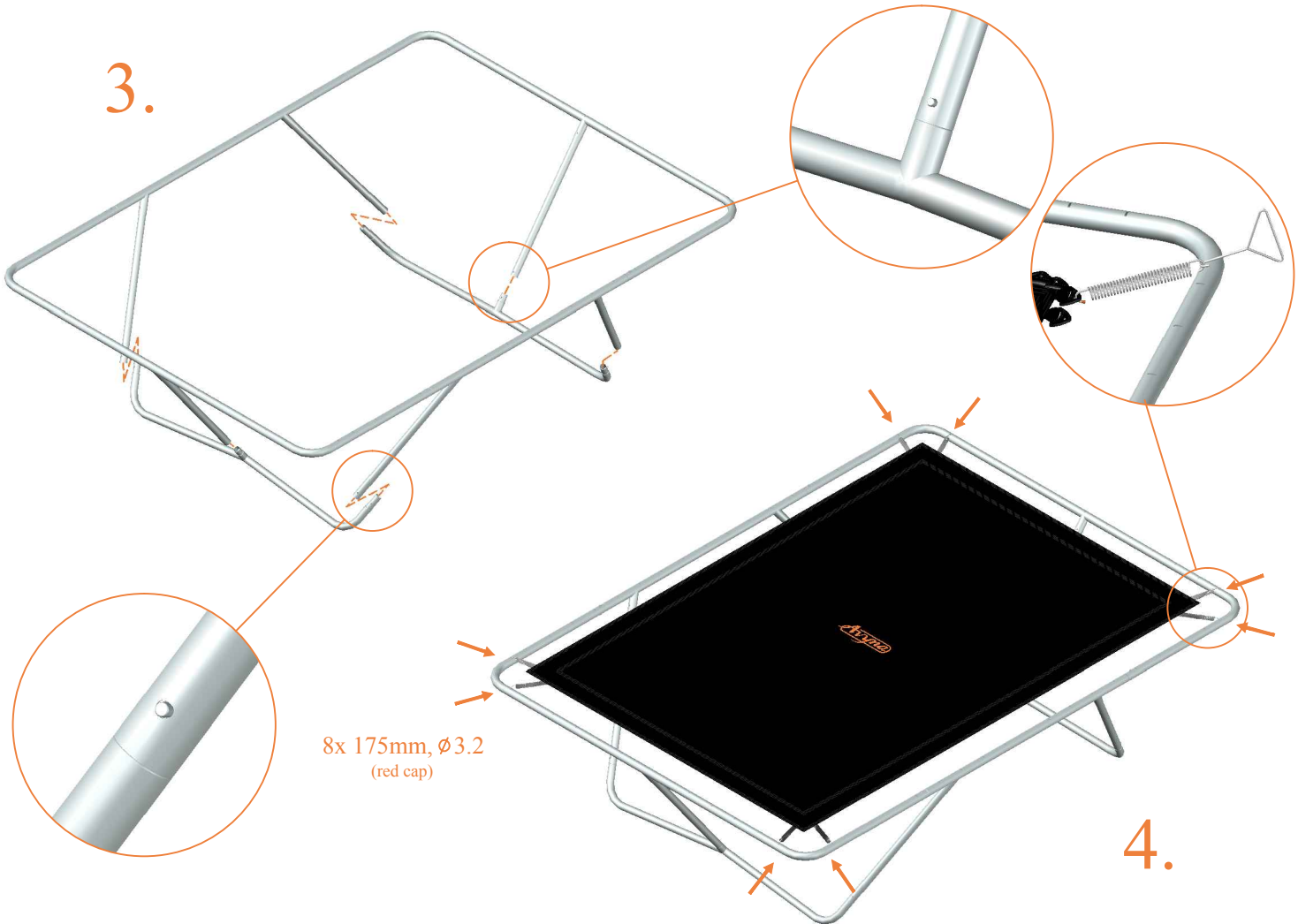

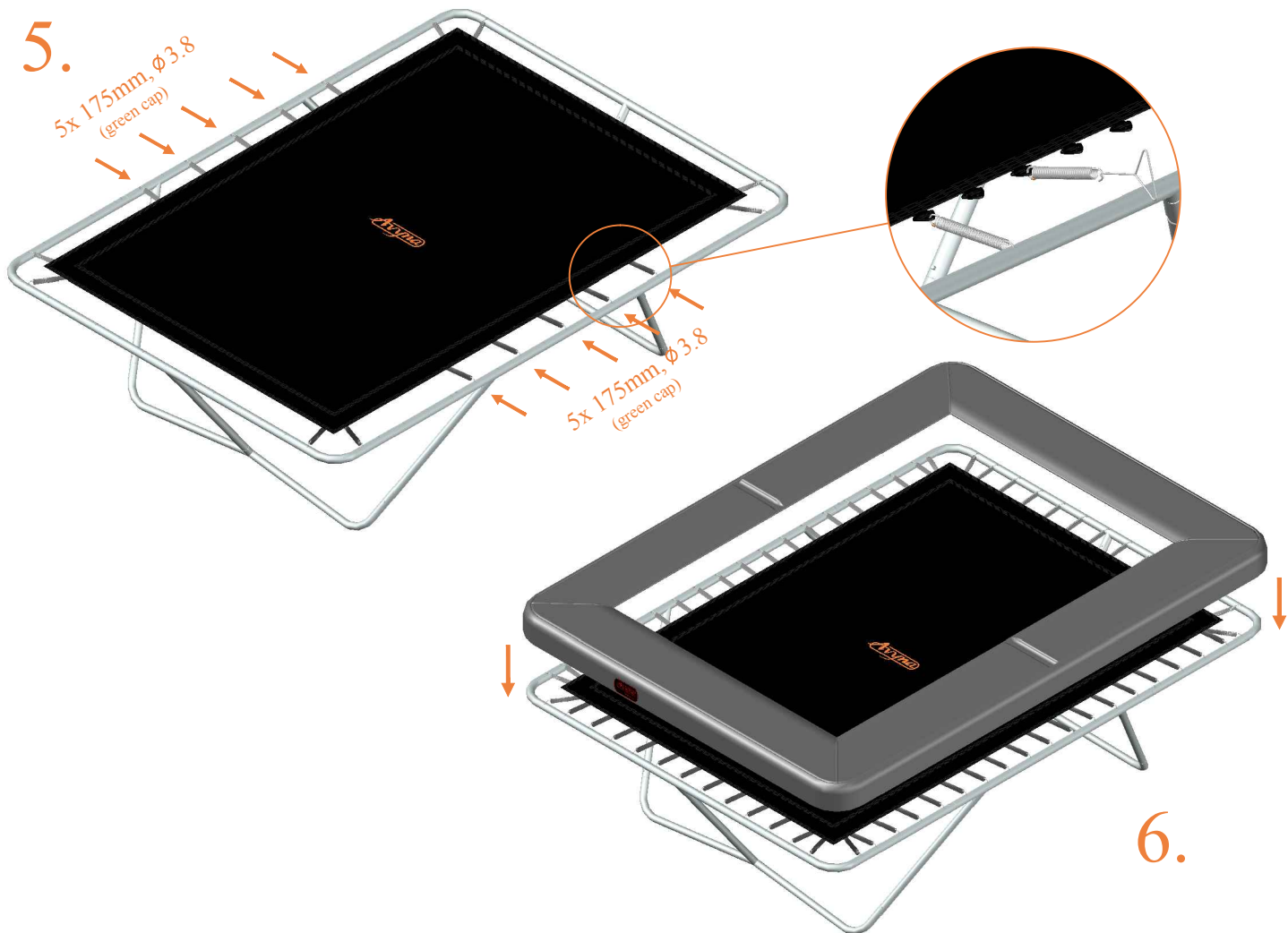

TEPL-ELAS-B

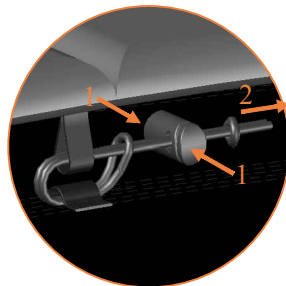
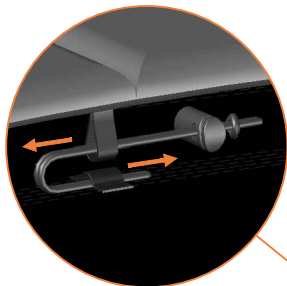

TEPL-ELAS-B

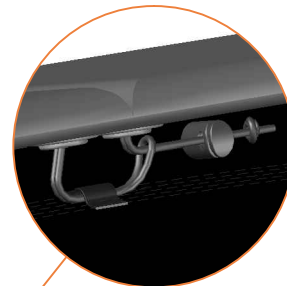

TEPL-ELAS-A

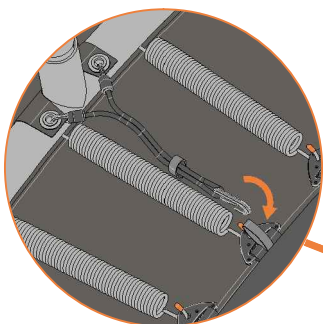

8x

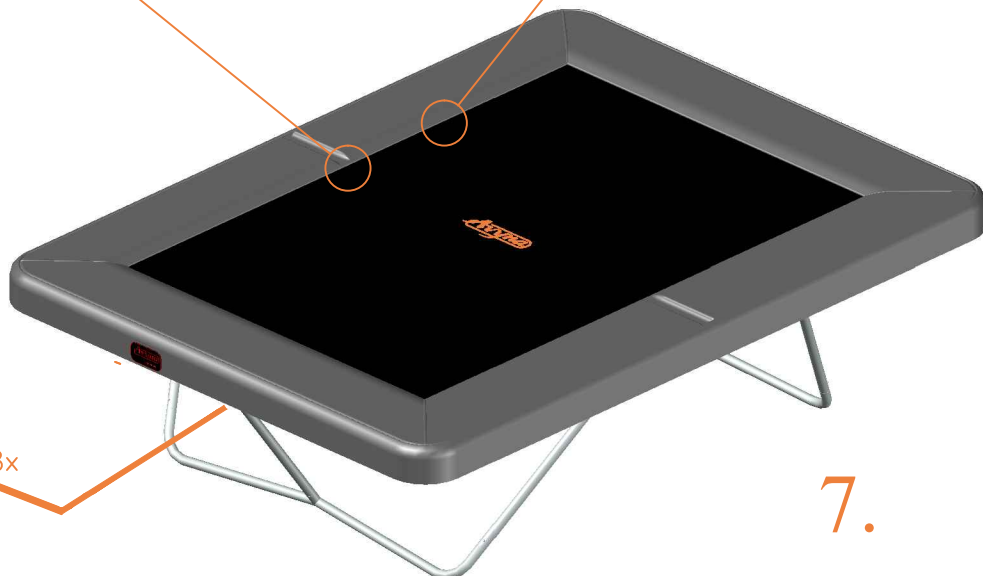

7.